



US00D695286S

(12) **United States Design Patent**
Katz

(10) **Patent No.:** **US D695,286 S**

(45) **Date of Patent:** **** Dec. 10, 2013**

(54) **PORTABLE COMPUTING DEVICE WITH
MULTI-SCREEN DISPLAY**

(76) Inventor: **R. David Katz**, Furlong, PA (US)

(**) Term: **14 Years**

(21) Appl. No.: **29/426,464**

(22) Filed: **Jul. 5, 2012**

(51) **LOC (9) Cl.** **14-02**

(52) **U.S. Cl.**

USPC **D14/315**; D14/306

(58) **Field of Classification Search**

USPC D14/306, 315-327, 439, 371-374, 336,
D14/337; D18/1, 2, 7, 11; 235/145 A, 145 R;
341/22, 23; 345/104, 156, 168, 169,
345/173; 361/679-679.09, 679.11,
361/679.21-679.23, 679.26, 679.27;
16/367

See application file for complete search history.

(56) **References Cited**

U.S. PATENT DOCUMENTS

5,128,662	A *	7/1992	Faila	345/1.3
6,343,006	B1 *	1/2002	Moscovitch et al.	361/679.04
6,667,878	B2 *	12/2003	Ponx	361/679.04
D645,467	S *	9/2011	Mitsuhashi	D14/374
2003/0090473	A1 *	5/2003	Joshi	345/173
2004/0212602	A1 *	10/2004	Nako et al.	345/173
2005/0088463	A1 *	4/2005	Schilling	345/699
2005/0264540	A1 *	12/2005	Niwa	345/173

* cited by examiner

Primary Examiner — Freda S Nunn

(74) *Attorney, Agent, or Firm* — LaMorte & Associates, P.C.

(57) **CLAIM**

The ornamental design for a portable computing device with multi-screen display, as shown and described.

DESCRIPTION

FIG. 1 is perspective view of a portable computing device with multi-screen display in a twice-folded configuration; FIG. 2 is a front view of the configuration of FIG. 1; FIG. 3 is a rear view of the configuration of FIG. 1; FIG. 4 is a top view of the configuration of FIG. 1; FIG. 5 is a bottom view of the configuration of FIG. 1; FIG. 6 is a left side view of the configuration of FIG. 1; FIG. 7 is a right side view of the configuration of FIG. 1; FIG. 8 is perspective view of the portable computing device with multi-screen display in a once-folded configuration; FIG. 9 is a front view of the configuration of FIG. 8; FIG. 10 is a rear view of the configuration of FIG. 8; FIG. 11 is a top view of the configuration of FIG. 8; FIG. 12 is a bottom view of the configuration of FIG. 8; FIG. 13 is a left side view of the configuration of FIG. 8; FIG. 14 is a right side view of the configuration of FIG. 8; FIG. 15 is perspective view of the portable computing device with multi-screen display in an unfolded configuration; FIG. 16 is a front view of the configuration of FIG. 15; FIG. 17 is a rear view of the configuration of FIG. 15; FIG. 18 is a top view of the configuration of FIG. 15; FIG. 19 is a bottom view of the configuration of FIG. 15; FIG. 20 is a left side view of the configuration of FIG. 15; FIG. 21 is a right side view of the configuration of FIG. 15; and, FIG. 22 is perspective view of the portable computing device with multi-screen display in a partially folded configuration.

1 Claim, 22 Drawing Sheets

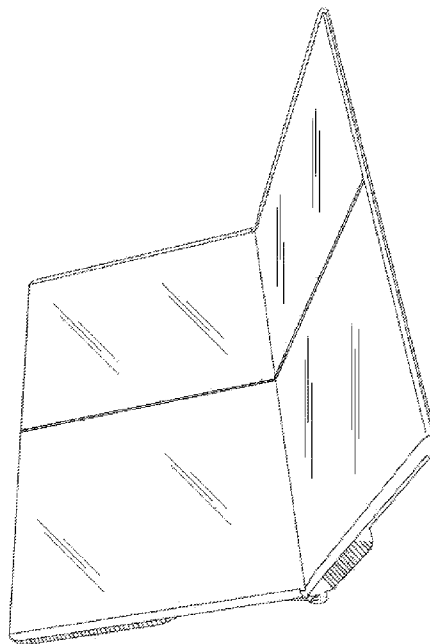

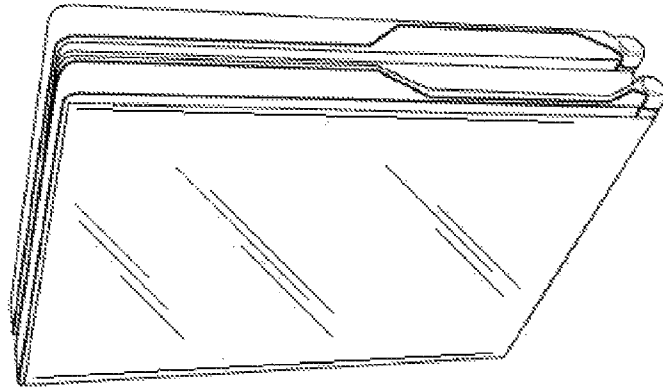

Fig. 1

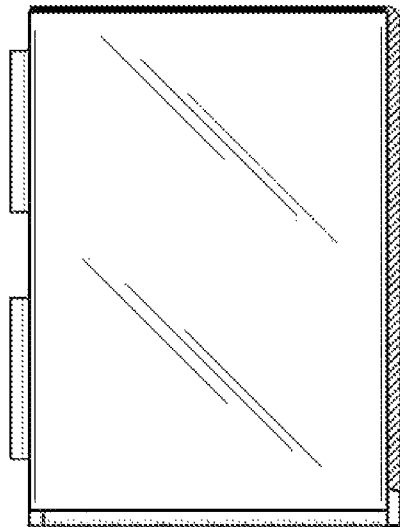

Fig. 2

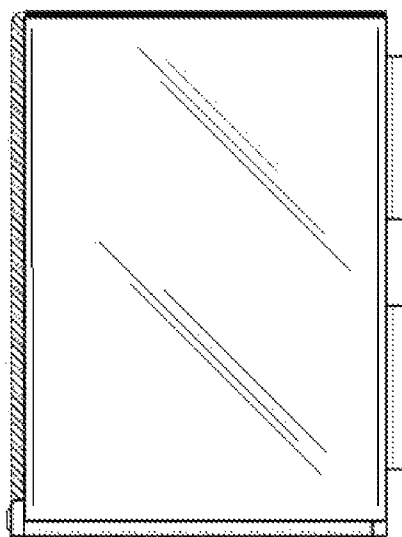

FIG. 3

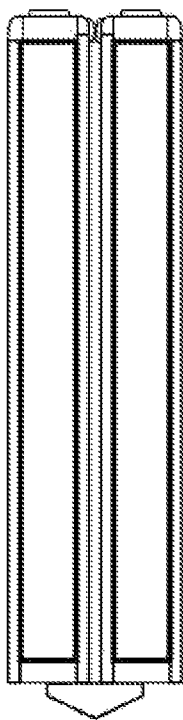

Fig. 4

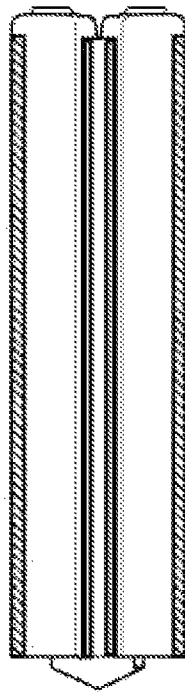

Fig. 5

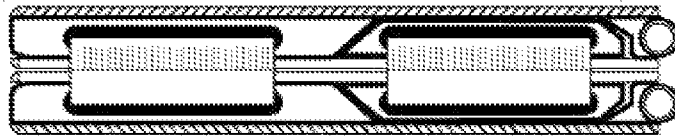

Fig. 6



Fig. 7

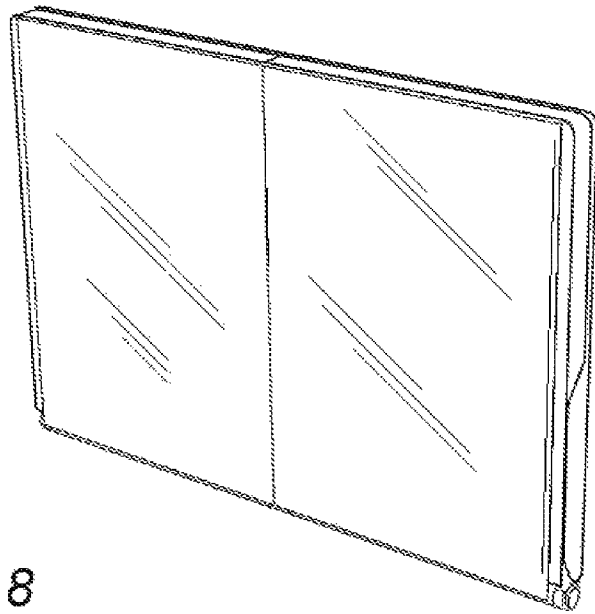

Fig. 8

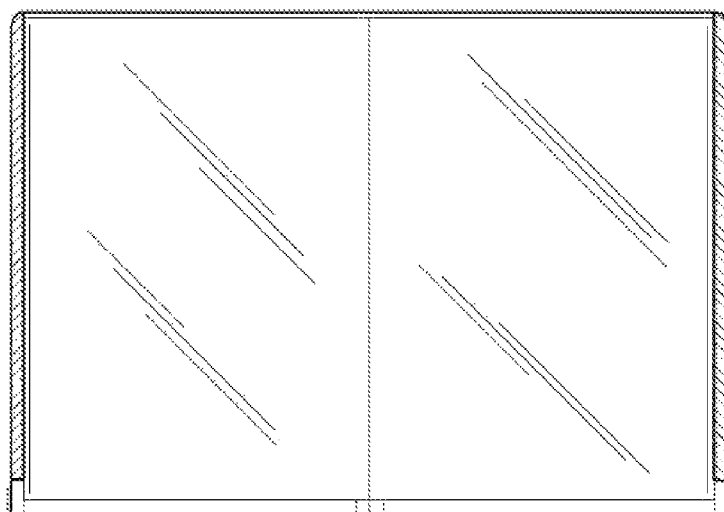

Fig. 9

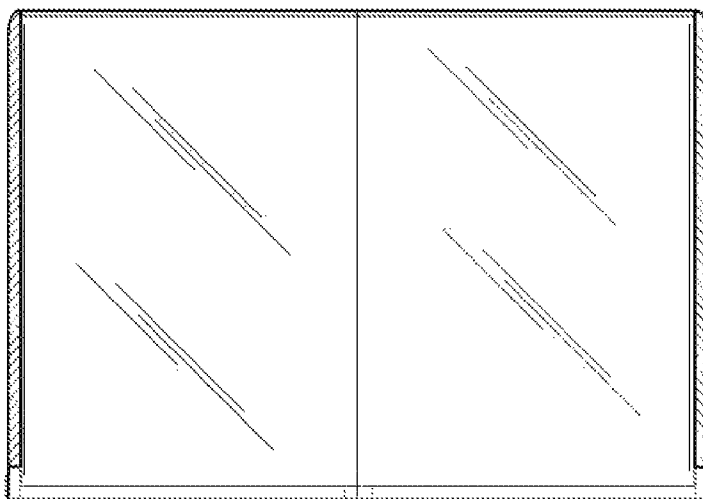

Fig. 10

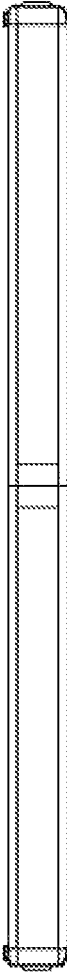

Fig. 11



Fig. 12



Fig. 13



Fig. 14

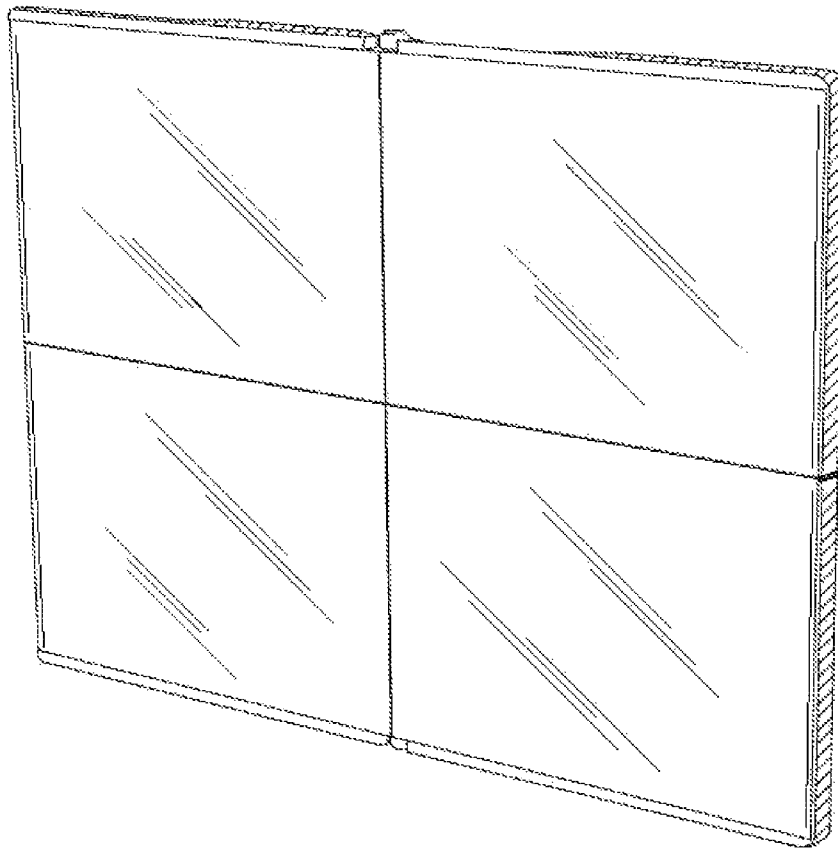

Fig. 15

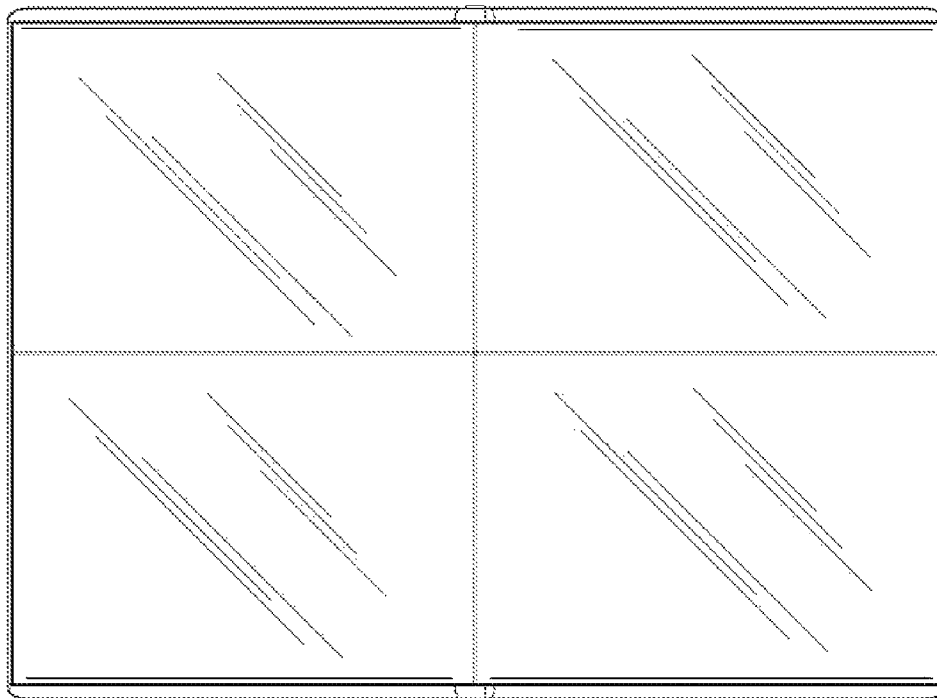

Fig. 16

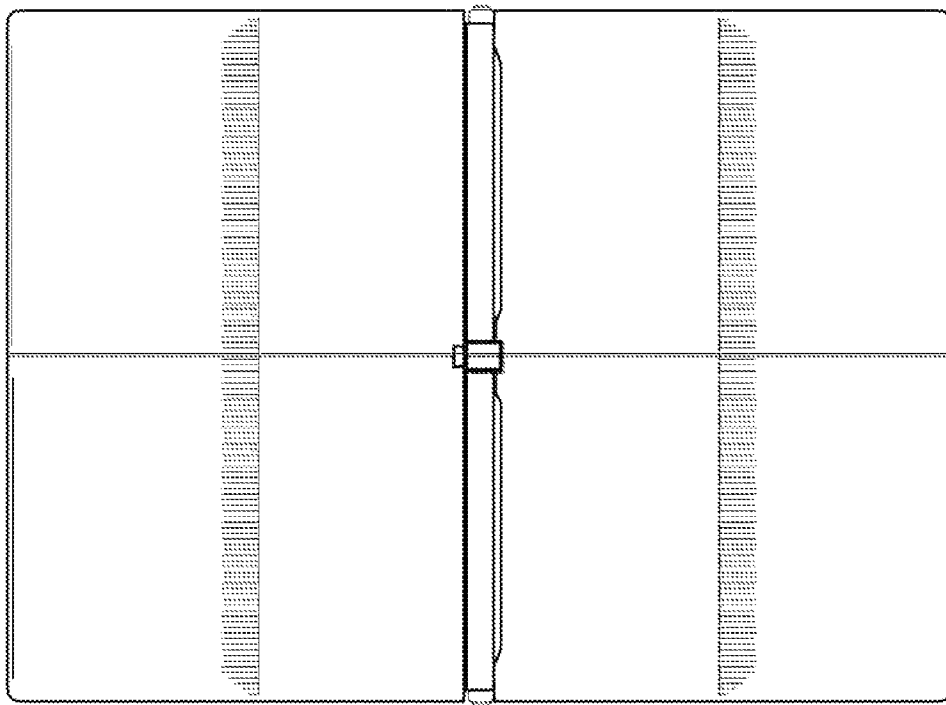

Fig. 17

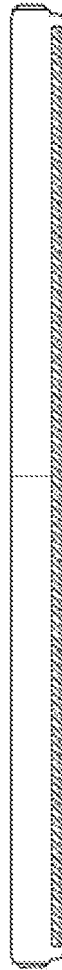

Fig. 18

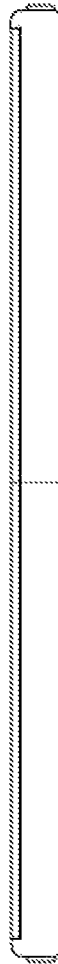

Fig. 19



Fig. 20



Fig. 21

