



US00D738438S

(12) **United States Design Patent**
Cummings

(10) **Patent No.:** **US D738,438 S**

(45) **Date of Patent:** **** Sep. 8, 2015**

- (54) **SWEPT WING AIRPLANE PROJECTILE**
- (71) Applicant: **Peter Cummings**, Tsim Sha Tsui (HK)
- (72) Inventor: **Peter Cummings**, Tsim Sha Tsui (HK)
- (73) Assignee: **KMA Concepts Limited**, Tsim Sha Tsui, Kowloon (HK)
- (**) Term: **14 Years**
- (21) Appl. No.: **29/489,404**

D251,454	S	*	3/1979	Takahashi	D21/447
D306,997	S	*	4/1990	Andrews	D12/331
D308,043	S	*	5/1990	Butler	D12/342
D342,717	S	*	12/1993	Mrdeza et al.	D12/333
D394,039	S	*	5/1998	Cummings	D12/333
D501,178	S	*	1/2005	Han	D12/319
D583,295	S	*	12/2008	Au	D12/343
D616,805	S	*	6/2010	Zha	D12/343
D622,653	S	*	8/2010	Moore et al.	D12/319
D627,404	S	*	11/2010	Suzuki	D21/447
D677,613	S	*	3/2013	Luther	D12/319
D690,254	S	*	9/2013	Manzhelii	D12/319
8,888,038	B2	*	11/2014	Bichler et al.	244/53 B
2014/0158812	A1	*	6/2014	Luther	244/2
2014/0220850	A1	*	8/2014	Kratz et al.	446/64

- (22) Filed: **Apr. 29, 2014**
- (51) **LOC (10) Cl.** **21-01**
- (52) **U.S. Cl.**
USPC **D21/447**
- (58) **Field of Classification Search**
USPC D12/319, 322, 323, 326, 327, 328, 329,
D12/330, 339, 341, 342, 343, 344, 345;
D21/436, 438, 439, 440, 441, 446, 447,
D21/448, 449, 450, 453
CPC B64C 39/00; B64C 30/00; B64C 29/00
See application file for complete search history.

* cited by examiner

Primary Examiner — Robert M Spear
Assistant Examiner — Marissa J Cash
(74) *Attorney, Agent, or Firm* — LaMorte & Associates, P.C.

(57) **CLAIM**
The ornamental design for a swept wing airplane projectile, as shown and described.

DESCRIPTION

FIG. 1 is a top perspective view of a swept wing airplane projectile;
FIG. 2 is a front view thereof;
FIG. 3 is a rear view thereof;
FIG. 4 is a left side view thereof;
FIG. 5 is a right side view thereof;
FIG. 6 is a top view thereof; and,
FIG. 7 is a bottom view thereof.

1 Claim, 5 Drawing Sheets

- (56) **References Cited**
U.S. PATENT DOCUMENTS
- | | | | | | | |
|-----------|---|---|---------|------------|-------|---------|
| 2,565,176 | A | * | 8/1951 | Hockett | | 446/64 |
| D198,038 | S | * | 4/1964 | Huston | | D21/447 |
| D219,042 | S | * | 10/1970 | King | | D21/448 |
| 3,576,300 | A | * | 4/1971 | Palfreyman | | 244/36 |
| 3,619,937 | A | * | 11/1971 | Thompson | | 446/66 |
| D226,718 | S | * | 4/1973 | McAlister | | D21/438 |
| D244,265 | S | * | 5/1977 | Opfer | | D12/333 |

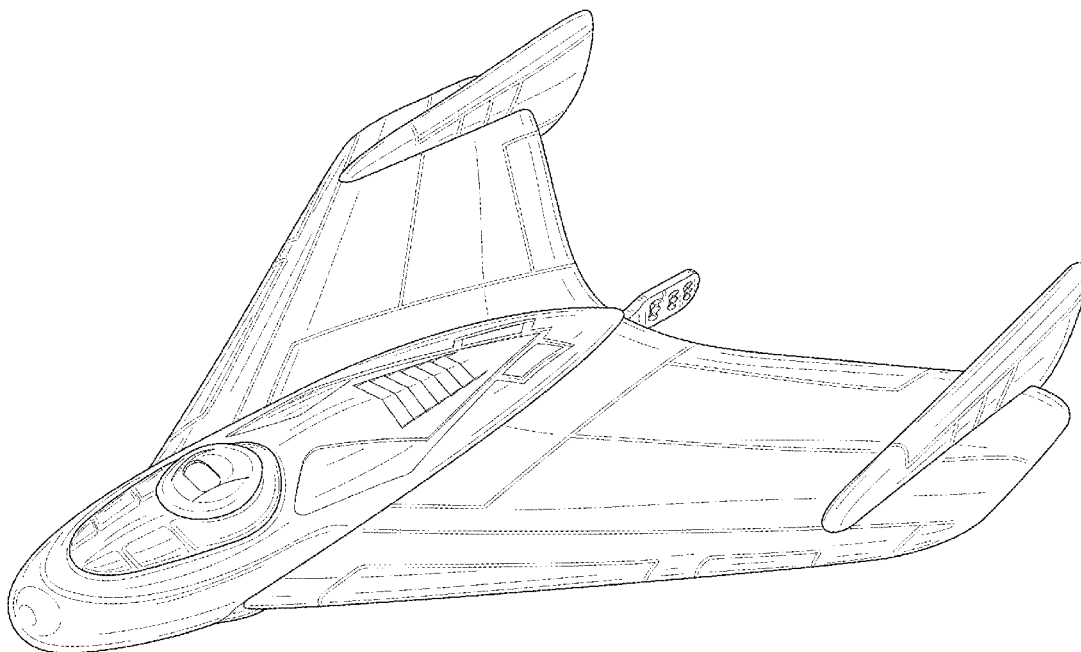

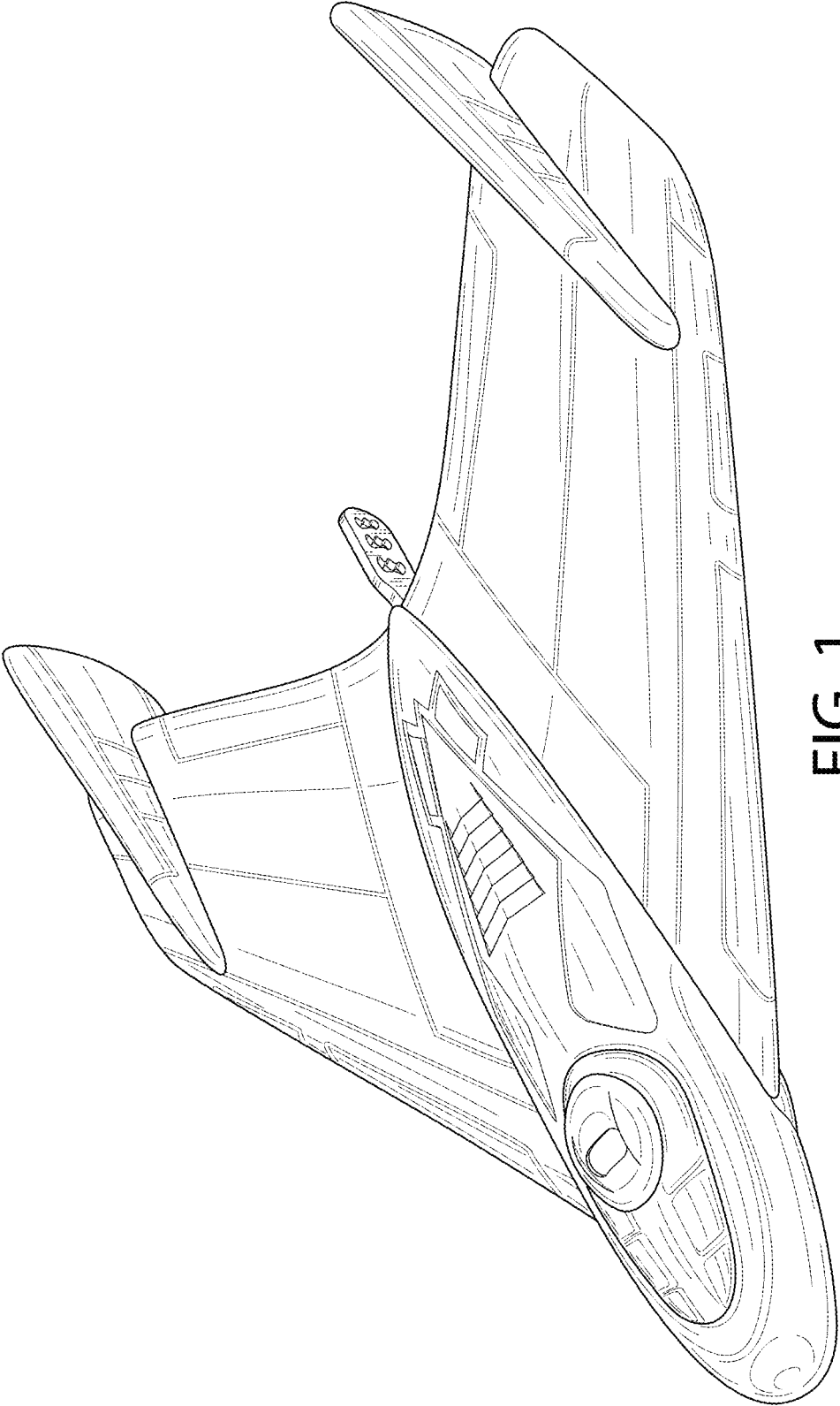

FIG. 1

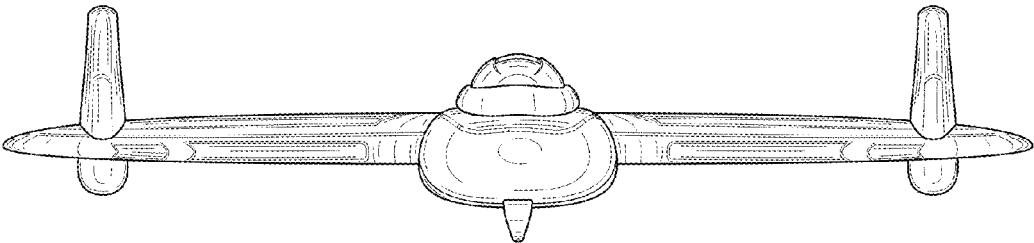

FIG. 2

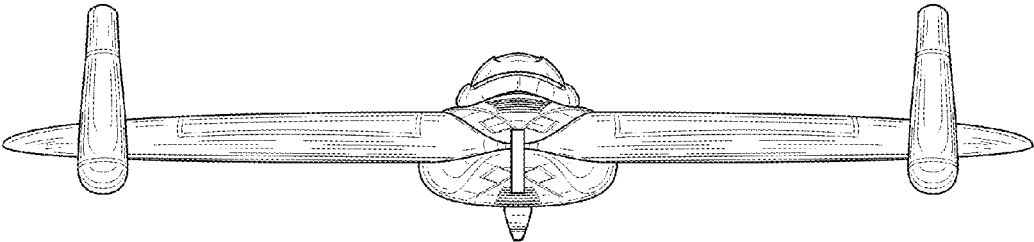

FIG. 3

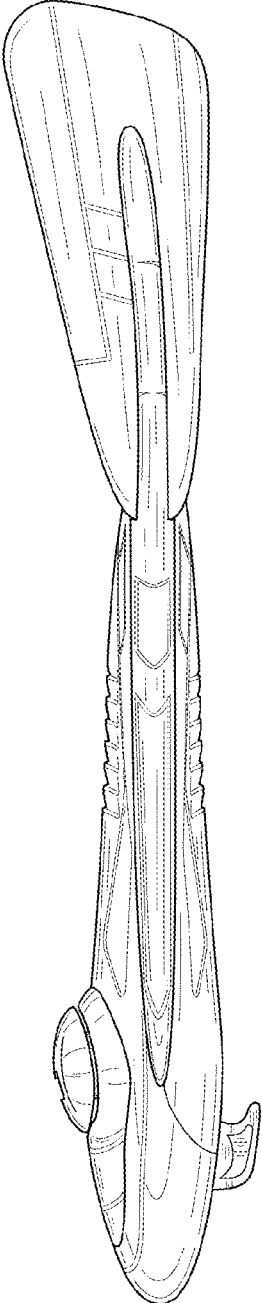

FIG. 4

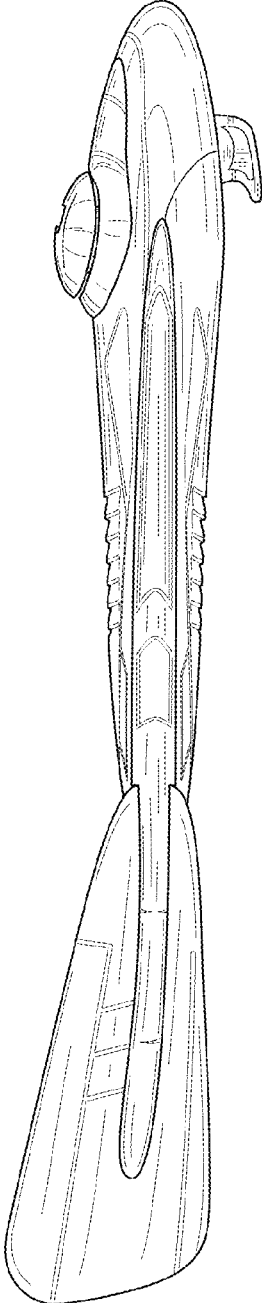

FIG. 5

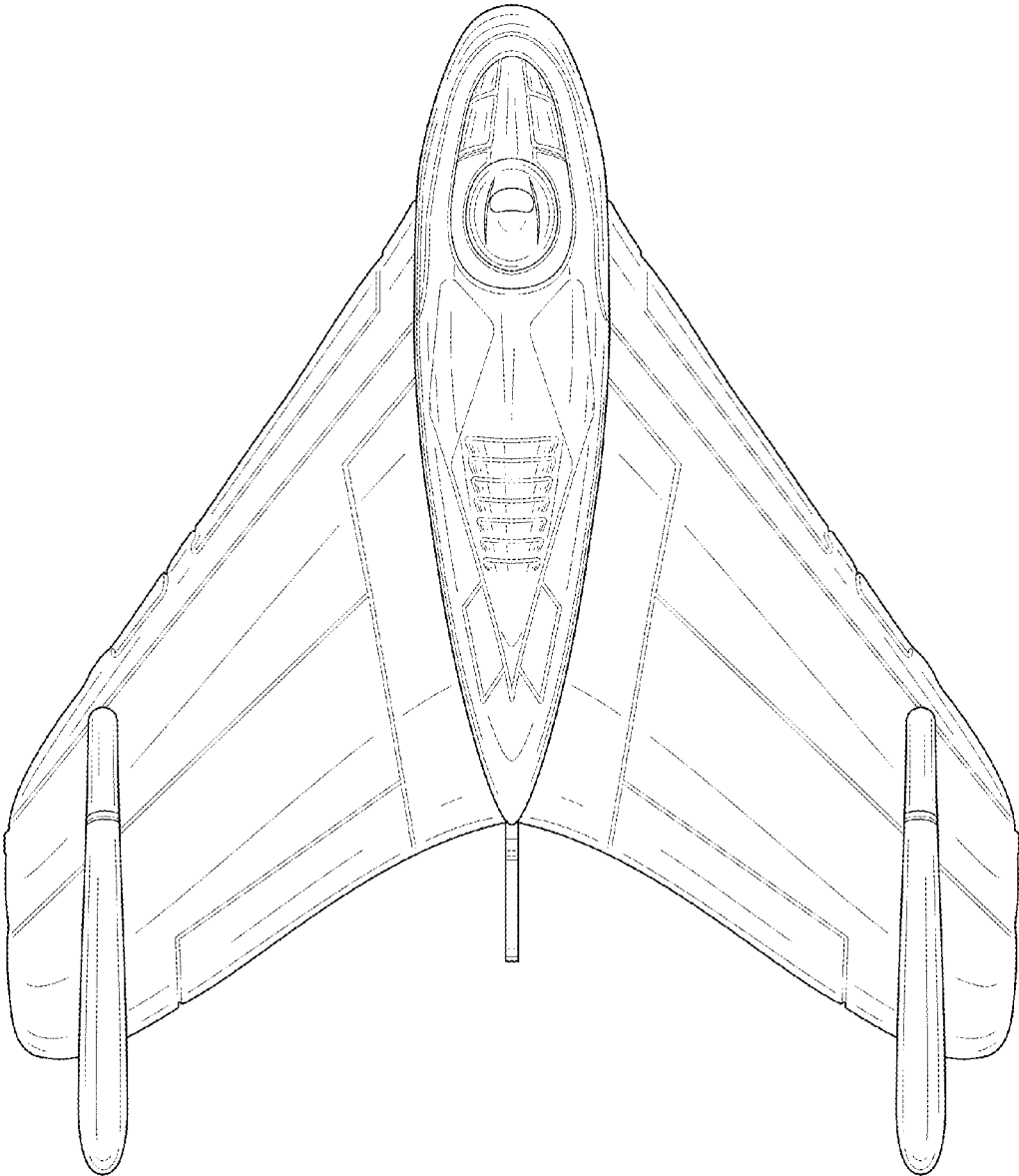

FIG. 6

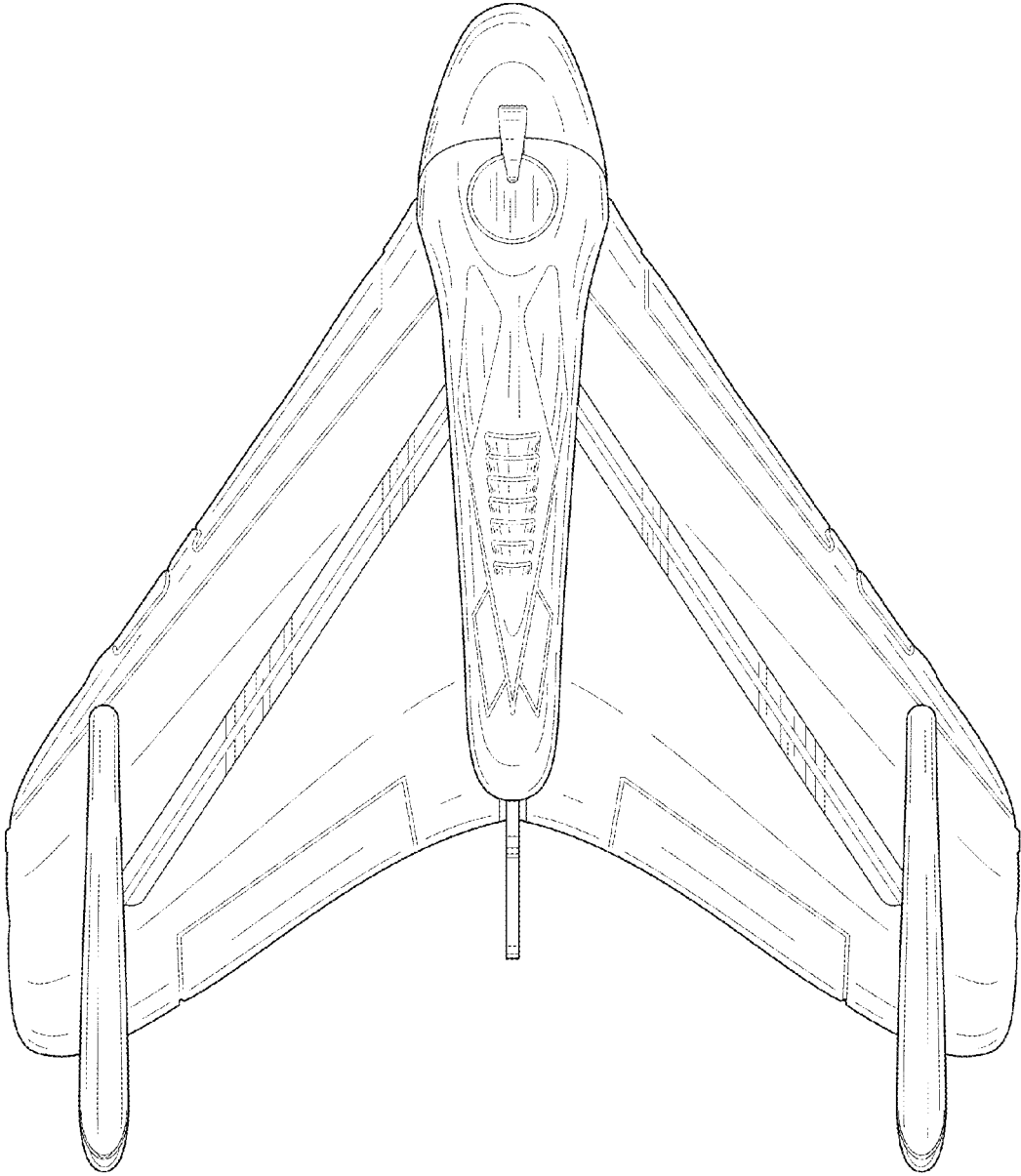

FIG. 7